

STM M28 Omni-purpose Module

NEXO

STM Scale Through Modularity

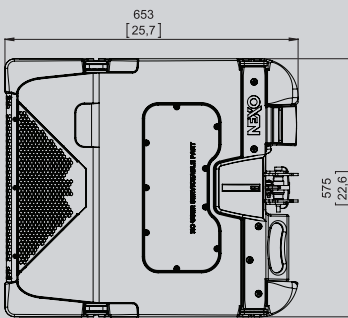
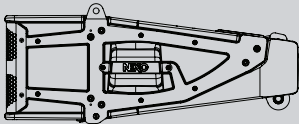
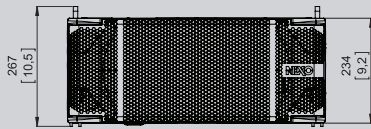

The 'fourth element' in the suite of NEXO STM compatible loudspeaker modules, the M28 is an injection-moulded all-purpose 2-way loudspeaker cabinet, providing 90°/120° of horizontal dispersion and 0° to 15° splaying angle between modules.

M28 is the same width as the STM M46 main cabinet, 2/3 height, and can either be arrayed in the same column with M46 in a large-format STM system, arrayed in the same column as B112 bass cabinet in a mid-format STM system, or used independently from the M46 and B112.

Powered by the NEXO NXAMP Powered TDC controller, the M42 exhibits high SPL output, superior horizontal control and stable dispersion.

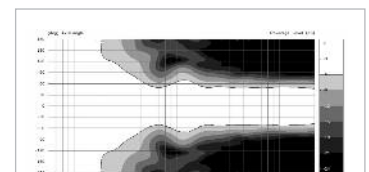

STM M28 90° CDD Horizontal Coverage

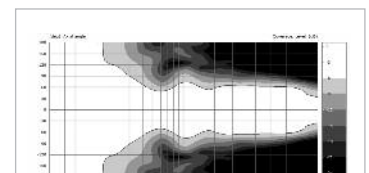

STM M28 120° CDD Horizontal Coverage

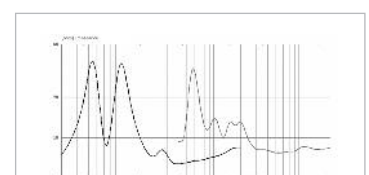

STM M28 impedance (black = LF, grey = HF)

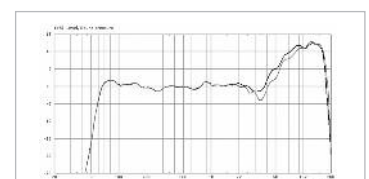

STM M28 on-axis frequency response (black = 90° CDD, grey = 120° CDD)

Key Features

- 2 x 8 inch LF Drivers
- 2 x HF Compression Driver
- 141dB peak SPL
- Frequency response: 60Hz-20kHz
- H234mm/W575mm/D653mm
- 37Kg/82lb

System Applications

- Live sound
- Theatres
- Conference facilities and auditoria
- Houses of Worship

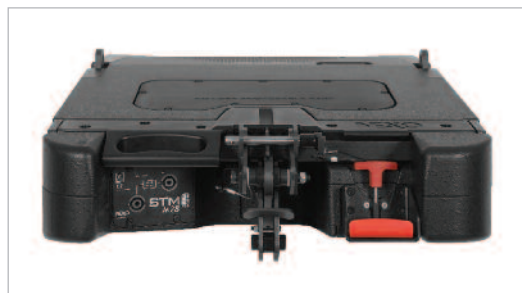

M28 features innovative CompassRig™ and REDLock™ rigging, enabling any size of system to be flown safely by one person. Compass Rig™ allows pre-setting of inter-cabinet angle values. REDLock™ handle locks front rigging points from rear of cabinet. All adjustments made from one position at rear of cluster.



NEXO
www.nexo.fr

STM M28 Omni-purpose Module

NEXO

STM  Scale
Through
Modularity

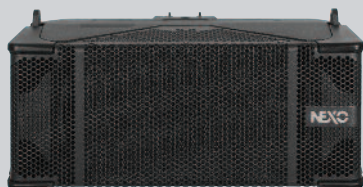

NEXO is one of the world's leading sound reinforcement loudspeaker manufacturers. Founded in 1979, the company is dedicated to crafting practical solutions with solid engineering. Each new design begins with a proprietary sophisticated computer simulation process that allows every parameter to be extensively modeled and simulated, leading to breakthrough cost and performance gains. NEXO's comprehensive product line includes loudspeakers, analogue and digital control electronics and amplification; all designed to deliver consistent sound quality and long term reliability for a broad range of applications.

NEXO S.A.
Parc d'Activité
du Pré de la Dame Jeanne
B.P. 5
60128 PLAILLY
Tel: +33 (0) 3 44 99 00 70
Fax: +33 (0) 3 44 99 00 30
e-mail: info@nexo.fr

NEXO LatAm
Tel: +1 305 677 9322
Fax: +1 360 234 7870
e-mail: info@nexo.fr

NEXO Asia
GPO Box 806
Hong Kong
SAR China
Tel: +852 9096 3472
Fax: +852 2104 3214
e-mail: info@nexo.fr

NEXO
www.nexo.fr

STM M28 with NXAMP 4x4

Frequency Response [a]	65Hz – 19kHz ±3dB
Usable Range @-6dB [a]	60Hz – 20kHz
Sensitivity 1W @ 1m [b]	106dB SPL Nominal (120° horizontal coverage) 107dB SPL Nominal (90° horizontal coverage)
Nominal Peak SPL @ 1m [b]	140dB Peak (120° horizontal coverage) 141dB Peak (90° horizontal coverage)
Dispersion [c]	Configurable 90°-120° Horizontal x 0-15° vertical
Crossover Frequency	900Hz (Active)
Nominal Impedance	LF: 8 Ω (6 Ω min) - HF: 8 Ω (6 Ω min)
Amplified Controller	NXAMP4x4 - 3xSTM M28 in parallel on 2 NXAMP4x4 channels - 2x4000W/2Ω

PRODUCT FEATURES

Components :	LF: 2 x 8" (20cm) high excursion 16 Ω Neodymium drivers HF: 2 x 2.5" voice coil, 1.4" throat Neodymium 16 Ω drivers, Ketone Polymer diaphragm
Height x Width x Depth	234 x 575 x 653 mm – 9.2" x 22.6" x 25.7"
Weight : Net	37kg – 82lbs
Connectors	2 x NLT4-MDV Speakon 4 poles
Construction	PU Composite Low Density – Polyurethane water based black coating
Fittings:	Handles 3 handles (2 sides and 1 rear) Front Perforated Dark Grey Metal Grille Rigging Integral 3 points flying system. Intercabinet angle adjustments from 0.2° to 15° in logarithmic steps.

SYSTEM OPERATION

Electronic Controller	The NEXO NXAMP4x4 presets are precisely matched to the STM Series cabinets and include sophisticated protection algorithms. Using STM Series cabinets without a properly connected NEXO NXAMP4x4 will result in poor sound quality and can damage components.
Sub-Bass	STM S118 extends system low frequency response down to 25Hz
Speaker Cabling	1-/1+: LF - 2-/2+: MF/HF

As part of a policy of continual improvement, NEXO reserves the right to change specifications without notice.

[a] Response data: Anechoic Far Field for the STM M28 + NXAMP4x4.

[b] Sensitivity & Peak SPL data : these will depend on spectral distribution and crest factor of program material. Measured with band limited Pink Noise. Data are for speaker + amplified controller. Peak SPL is at clipping of NXAMP4x4.

[c] Directivity data : obtained by computer treatment on off axis response curves.

LIMITED WARRANTY

NEXO loudspeakers and electronics are covered against defects in workmanship or materials for a period of two (2) years from the original date of purchase. At the option of NEXO the defective item will be repaired/replaced with no charge for materials/labour. The item is to be adequately packaged and dispatched, pre-paid, to a NEXO authorised distributor/service centre. Unauthorised repair shall void the warranty. The NEXO warranty does not cover cosmetics or finish and does not apply to any items which in NEXO's opinion have failed due to used abuse, accidents, modifications or any type of misuse. All images and text herein are the property of NEXO SA, and deemed accurate, although specifications are subject to change without notice.